

Installation and operation Manual

AXIbox 11K



INDEX

1	TARGET GROUP OF THIS DOCUMENT	3
2	GENERAL REGULATIONS AND SAFETY MEASURES	3
3	DESCRIPTION OF THE PRODUCT	4
3.1	Function and intended use	4
3.2	Scope of delivery	4
3.3	Technical data	4
4	OPERATION	5
4.1	Operation with Access restriction	5
4.1.1	Starting the charging process with RFID-Card	5
4.1.2	Ending the charging process	5
4.1.3	Control via App	5
4.2	Plug & Play mode	6
4.2.1	Starting the charging process	6
4.2.2	Ending the charging process	6
4.3	Changing the operation mode	6
4.4	Behaviour in the event of an error	6
5	REQUIREMENTS	7
5.1	Electrical requirements	7
5.1.1	Supply cable	7
5.1.2	Protection devices	7
5.2	Requirements for the installation site	7
6	INSTALLATION	8
6.1	Wall mounting the housing	8
6.2	Setting the operating mode	9
6.2.1	Control via RFID	9
6.2.2	Plug & Play	9
6.3	Electrical installation	10
6.4	Final work	10
7	TROUBLESHOOTING	11
8	DISPOSAL	13

1 Target group of this document

This document refers to the assembly, installation and operation of the AXIbox 11K charging station and is intended for the installer and the users. Chapters 5-7 are intended exclusively for the charging station installer with the appropriate qualification.

2 General regulations and safety measures



Warning



The input and output voltages of this unit are dangerous high voltages that can endanger human life. Please be sure to observe all warnings and operating instructions on the unit and in the manual. Unauthorised and unprofessional service personnel should not remove the cover of this unit.

Installation must be carried out by a qualified electrician who is familiar with the contents of the installation instructions and knows about and can apply the applicable standards and laws. National and regional regulations must be observed for assembly and installation.

Read these installation instructions before installation.

Read these operating instructions before operating the AXIbox 11K and ensure that this charging station is only operated by persons who have read these instructions. Keep these instructions in a safe place.

Non-observance of these instructions as well as non-intended use of the charging station can lead to injuries or even death as well as damage to property.

Persons with pacemakers should not carry out any installation or maintenance work on the AXIbox.

Do not operate the charging system near explosive or flammable materials, chemicals, vapours and other hazardous objects.

Do not clean the vehicle with a pressure washer while the charging cable is connected.

Do not disconnect the charging station from the vehicle during charging.

Check the charging system for damage to the housing, cable or plug before use. A damaged wallbox must not be put into operation.

Do not immerse the wallbox and the charging plug in water and protect the connections from moisture. Keep the charging socket dry and clean.

When operating the charging coupler, always grasp the handle of the plug. Do not touch the contacts of the plug or hold it by the cable.

As a user, do not open the housing of the wallbox.

No modifications or conversions may be carried out on the charging station.

No adapters or cable extensions may be used.

The charging cable must not be kinked, pinched, run over or otherwise damaged.

Keep children away from the charging station.

The car must not be driven during charging.

3 Description of the product

3.1 Function and intended use

The AXIbox 11K is used for charging electric cars. There is a choice of two modes, which can be set during installation: In Plug & Play mode, no authentication by the user is necessary. Charging can be started without unlocking after inserting the charging plug into the car's charging socket. If, on the other hand, the charging mode with access restriction is selected, the charging process does not start automatically when the plug is inserted, but must first be authorised by an RFID card at the wallbox or with the App. This prevents unauthorised use.

3.2 Scope of delivery

The AXIbox 11K is delivered with the following parts:

- 1 x AXIbox 11K housing with electronics and pre-installed charging cable with type 2 plug
- 6 x Screws with associated expansion pipes for wall mounting
- 1 x Seal for sealing the screw connection
- 1 x Cable clamp for fixing the supply cable with associated screws
- 1 x Cable holder
- 5 x Wire end ferrules
- 2 x RFID cards
- 1 x Template for drilling the holes for wall mounting
- 1 x Allen key for opening and closing the housing

3.3 Technical data

Charging power	11 kW
Charging current	16 A per phase
Rated voltage	400 V AC
Plug	Type 2
Cable length	7 m
Size (HxBxT)	325 x 181 x 87 mm
Weight	3,6 kg
DC fault current monitoring	>6 mA DC
Protection classes	IP65, IK10
Grid connection	3P+N+PE 400 V AC 16 A 50/60 Hz

4 Operation

4.1 Operation with Acces restriction

In this operating mode, the wallbox is locked against unauthorised use. Authentication with one of the supplied RFID cards or control via App is required for operation.

4.1.1 Starting the charging process with RFID-Card

1. Connect the wallbox to the car to be charged via the cable. Make sure that the cable is completely unwound. The LED flashes yellow every 1 second.
2. Unlock the wallbox by holding the RFID card at the point marked "CARD" on the housing of the AXIbox.
3. The charging process starts. During the charging process, the LED flashes green every 1 second.

4.1.2 Ending the charging process

1. Stop the charging process with the RFID card. When the car is fully charged, charging will stop.
2. Disconnect the charging plug from the vehicle and stow it at the wallbox.

4.1.3 Control via App

The AXIbox can be controlled via the Evcharge app. The charging process can be started and stopped, and a charging schedule can be created. The variation of the charging current is also possible via the app. The RFID cards can also be integrated into the app and additional users can be activated. Please follow the steps shown in the manual on our homepage (Evcharge Manual) to connect your charger to the app.



If charging is started via App, the charging process must also be stopped with the App. If charging is started with the RFID card, the charging process must also be stopped with the RFID card. When the car is fully charged, charging will stop automatically.

- Requirements: 2,4 GHz W-LAN; Bluetooth, W-LAN and location must be activated at the smartphone

4.2 Plug & Play mode

No authentication is required in this operating mode.

4.2.1 Starting the charging process

1. Connect the wallbox to the car to be charged via the cable. Make sure that the cable is completely unwound.
2. Start the charging process on the vehicle. During the charging process, the LED flashes green every 1 second.

4.2.2 Ending the charging process

1. Stop the charging process at the car. When the car is fully charged, charging will stop.
2. Disconnect the charging plug from the vehicle and stow it in the wallbox.

4.3 Changing the operation mode

The change between the operating modes Plug & Play and operation with RFID card can only be carried out by an electrician. The change that must be made to the internal electronics is described under **Fehler! Verweisquelle konnte nicht gefunden werden.**

4.4 Behaviour in the event of an error

In the event of a fault, switch off the associated building-side fuse of the charging system and thus disconnect it from the power supply. Ensure that the fuse is not switched on again before rectifying the fault. Contact a qualified electrician.

5 Requirements

5.1 Electrical requirements

When making the electrical connection, the country-specific regulations, standards and application rules must be observed.

5.1.1 Supply cable

The power supply of the wallbox must be three-phase (3P + N + PE; min. 5 x 2,5 mm², depending on the locally applicable regulations, environmental conditions and installation type). The required conductor voltage is 400 V AC and a current of 16 A per phase with 50 Hz mains frequency.

5.1.2 Protection devices

The phases of the supply line must each be protected with miniature circuit breakers and residual current devices. The national regulations must be observed when dimensioning the miniature circuit breakers and residual current devices.

The AXIbox 11K has residual current monitoring for currents >6 mA DC. Therefore, the charging station must be fused with an RCD with at least type A. No other circuits may be connected to the residual current circuit breaker.

5.2 Requirements for the installation site

To control the AXIbox with the app, a W-Lan connection with 2.4 GHz is required at the installation site.

The AXIbox may only be mounted and operated vertically.

Mounting is permitted up to a maximum altitude of 2000 m above sea level.

The ambient temperature must not fall below -30°C and must not exceed 50°C.

The humidity must be in the range between 5% and 95%.

Do not install the charging station near explosive or flammable substances.

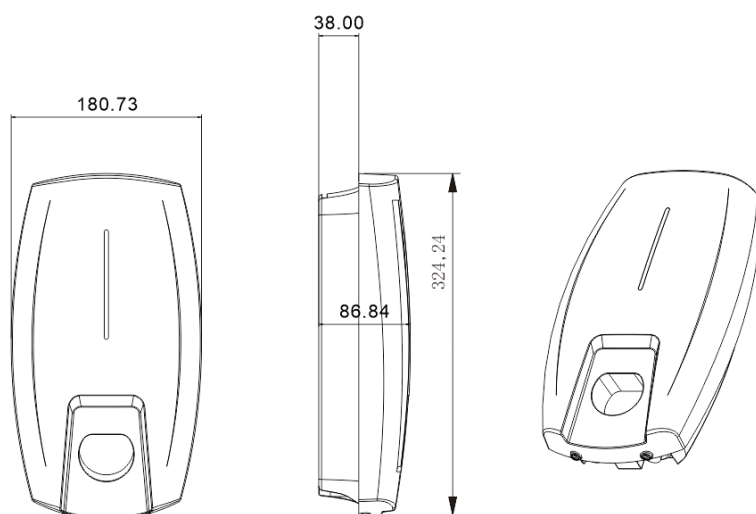

6 Installation

Electrical device should be installed, operated, serviced, and maintained only by qualified personnel. No responsibility is assumed by the manufacturer for any consequences arising out of the use of this device. A qualified person is one who has skills and knowledge related to the construction, installation and operation of electrical device and who has received safety training to recognize and avoid the hazards involved.

All applicable local, regional, and national regulations must be respected when installing, repairing, and maintaining this device.

6.1 Wall mounting the housing

To mount the AXIbox on the wall, follow the steps below:

1. Align the drilling template horizontally on the wall and mark the 3 drill holes on the wall.
2. Drill the 3 holes for the wall mounting of the wallbox and, if necessary, also the 3 holes for the cable holder. The top two screws can already be fastened in the wall with the expansion pipes so that the AXIbox can be hung from them later.
3. Open the two screws on the underside of the AXIbox to open the housing.
4. Hang the back of the housing on the two screws on the wall and fix the AXIbox in the wall with the third screw.
5. Seal the hole for the screw with the seal included in the scope of delivery.

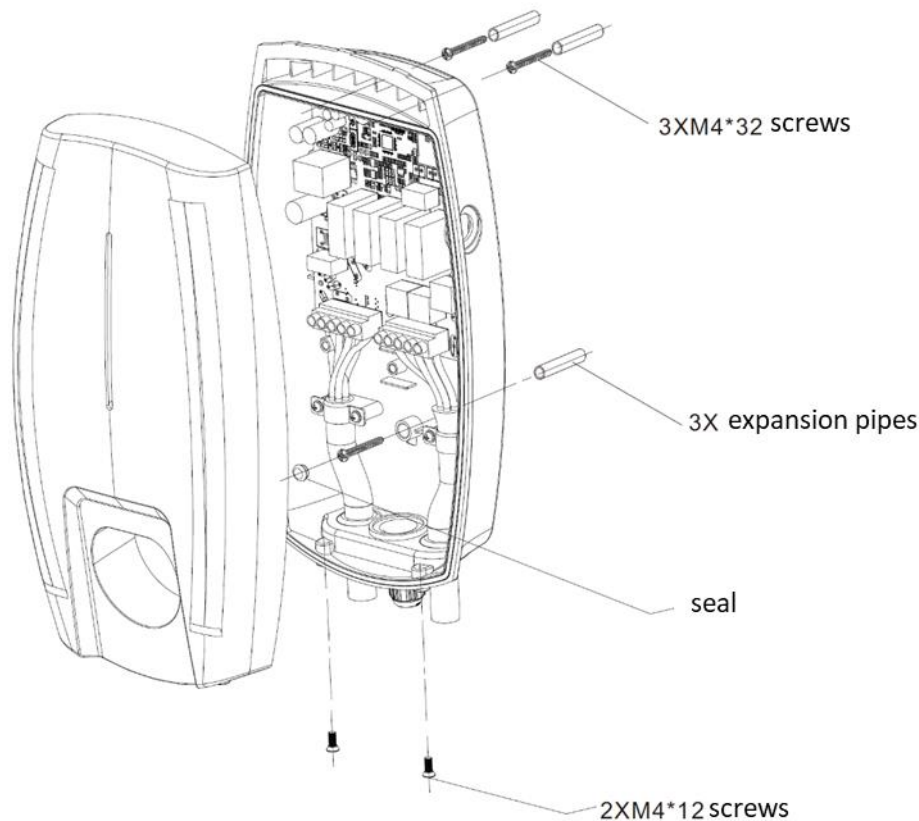

6.2 Setting the operating mode

The AXIbox has two operating modes. The changeover may only be carried out by a specialist, taking into account all necessary safety precautions.

6.2.1 Control via RFID

When delivered, the AXIbox is protected against unauthorised use by a lock. The charging process is started by the RFID cards supplied. If this operating mode is desired, no changes need to be made.

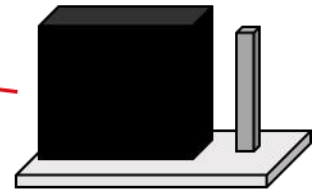
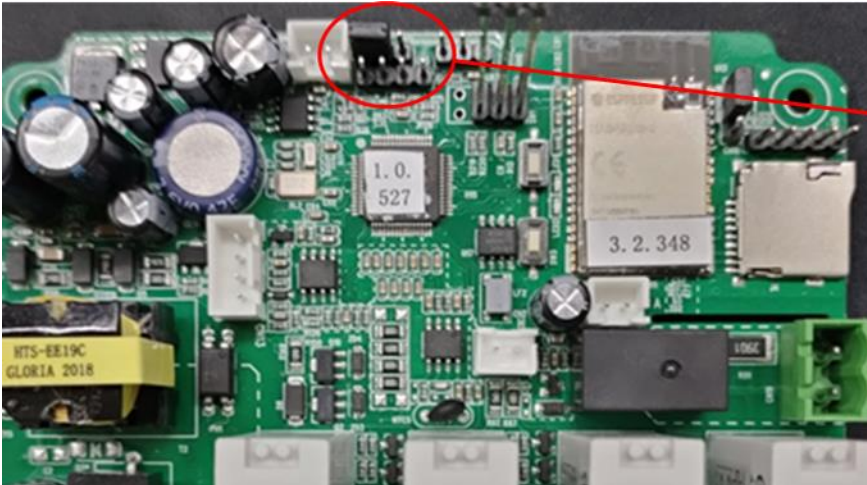

In order to use the RFID cards to activate the charging process, the jumper marked in the above image must be in the position shown. If the AXIbox was previously in Plug & Play mode, the jumper must be moved back to the position shown above to switch to RFID mode.

6.2.2 Plug & Play

In Plug & Play mode, charging can be started after inserting the charging plug into the car's charging socket without further activation. To switch to this mode, the jumper marked in the image below must be placed in the position shown.

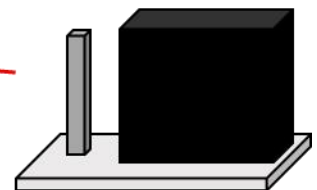

6.3 Electrical installation

The electrical supply to the wallbox is three-phase, a cable with 3 conductor phases, a neutral conductor and a PE conductor is required.

Feed the cable through the left-hand opening at the bottom of the AXIbox housing. Clamp the wires of the cable into the terminals provided. Use the wire end ferrules supplied and fix the cable inside the AXIbox with the sleeve.

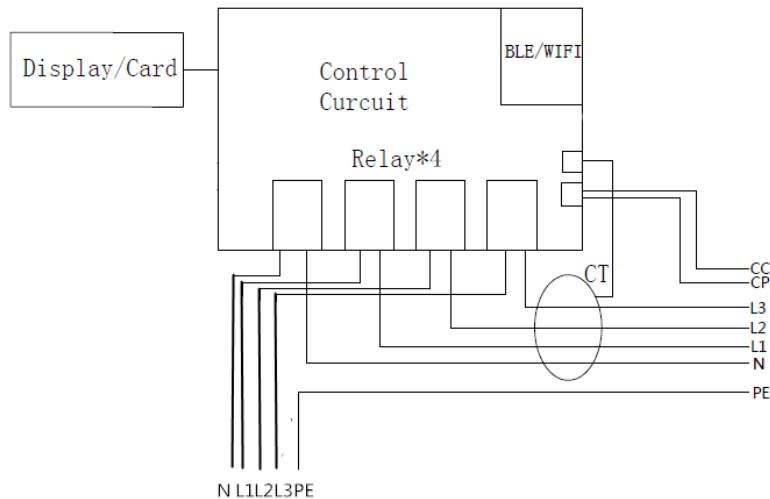

Schematic representation of the wiring











6.4 Final work









Put the housing cover back on the base and close the housing again with the two screws. The AXIbox is now ready for use as soon as the power supply is switched on.

Before commissioning, check the following:

- The selected location ensures easy operation and repair
- The charging station has been properly installed
- The circuit breakers of the supply line are appropriate
- There are no devices and objects on the charging station

7 Troubleshooting

State	LED State	Solutions
Standby	Flashing green, 1s on, 3s off 	
Charging	Breathing green, 1s on, 1s off 	
Cable connected	Breathing yellow, 1s on, 1s off 	
Self check	Green 1s, Yellow 1s, Red 1s 	
Software upgrade	Green, fast flash 	
Ground warning	Flashing yellow, 2s on, 2s off 	Check grounding contact
Relay fault	Red on 3s, yellow on 1s, red flash 1 time, yellow on 1s, red flash 1 time, yellow on 1s, and so on 	Please contact our support
Input polarity reverse	Red on 3s, yellow on 1s, red flash 2 times, yellow on 1s, red flash 1 time, yellow on 1s, and so on 	<ol style="list-style-type: none"> 1. Shut off the leakage current protection switch of power distribution cabinet immediately. 2. Check if AC input/output cables are normal, and if inverse connection of L/N input cables.
CP fault	Red on 3s, yellow on 1s, red flash 3 times, yellow on 1s, red flash 1 time, yellow on 1s, and so on 	Please contact our support
Leakage current fault	Red on 3s, yellow on 1s, red flash 4 times, yellow on 1s, red flash 1 time, yellow on 1s, and so on 	<ol style="list-style-type: none"> 1. Shut off the leakage current protection switch of power distribution cabinet immediately. 2. Check whether there is broken of AC output cables or low resistance connection to the earth.

<p>Input terminal overtemperature</p>	<p>Red on 3s, yellow on 1s, red flash 1 time, yellow on 1s, red flash 2 times, yellow on 1s, and so on</p> 	<ol style="list-style-type: none"> 1. Check the surrounding conditions of chargers installed whether there is heating device nearby. Make sure environmental temperature is under 60°C. 2. Check if the input terminals are in bad contact
<p>Relay overtemperature</p>	<p>Red on 3s, yellow on 1s, red flash 2 times, yellow on 1s, red flash 2 times, yellow on 1s, and so on</p> 	<p>Please contact our support</p>
<p>Under voltage fault</p>	<p>Red on 3s, yellow on 1s, red flash 3 times, yellow on 1s, red flash 2 times, yellow on 1s, and so on</p> 	<ol style="list-style-type: none"> 1. Check the input voltage from the backend. 2. If the voltage is under 184Vac for a short time, wait till the power grid recovers to normal voltage range.
<p>Over voltage fault</p>	<p>Red on 3s, yellow on 1s, red flash 4 times, yellow on 1s, red flash 2 times, yellow on 1s, and so on</p> 	<ol style="list-style-type: none"> 1. Check the input voltage from the backend. 2. If the voltage is over 276Vac for a short time, wait till the power grid recovers to normal voltage range.
<p>Overcurrent fault</p>	<p>Red on 3s, yellow on 1s, red flash 1 time, yellow on 1s, red flash 3 times, yellow on 1s, and so on</p> 	<ol style="list-style-type: none"> 1. Shut off the leakage current protection switch of power distribution cabinet immediately. 2. Check whether there is low resistance connection between AC output cables of the charger.
<p>Over frequency fault</p>	<p>Red on 3s, yellow on 1s, red flash 2 times, yellow on 1s, red flash 3 times, yellow on 1s, and so on</p> 	<ol style="list-style-type: none"> 1. Check the input voltage frequency from the backend. 2. If the frequency exceeds 63Hz for a short time, wait till power grid recover to normal frequency range.
<p>under frequency fault</p>	<p>Red on 3s, yellow on 1s, red flash 3 times, yellow on 1s, red flash 3 times, yellow on 1s, and so on</p> 	<ol style="list-style-type: none"> 1. Check the input voltage frequency from the backend. 2. If the frequency is lower than 47Hz for short time, wait till power grid recover to normal voltage range.
<p>Leakage detecting circuit fault while self-checkingl</p>	<p>Red on 3s, yellow on 1s, red flash 4 times, yellow on 1s, red flash 3 times, yellow on 1s, and so on</p> 	<p>Check the connection of the CT port</p>
<p>Lock fault</p>	<p>Red on 3s, yellow on 1s, red flash 3 times, yellow on 1s, red flash 4 times, yellow on 1s, and so on</p> 	<p>Please contact our support</p>

8 Disposal

The AXIbox is subject to the EU Directive 2012/19/EU on Waste Electrical and Electronic Equipment (WEEE). The AXIbox must therefore not be disposed of with household waste, but must be disposed of in accordance with national and regional regulations for electrical and electronic equipment. The unit should be rendered inoperable before disposal.

